

Fiber Optic Splice Closure

GDFOSC-D48/2

WHAT THIS PRODUCT DOES

GDI Technology, GDFOSC-D48/2 is one of the main equipment for user access points, applied for protective connection and distribution between two or more cables. The primary function is to connect distribution cable and indoor cable in the open air. It's widely used in communication systems, cable TV, optical cable network systems and others by virtue of steady structure, good sealing performance and easy construction.

CHARACTERISTICS

- The body is made of high quality engineering plastic with good strength
- With good waterproof design, the fiber optical splice closure can be applied into underground and aerial.
- Be equipped with 2 splice trays (each capacity is 24 cores)
- Excellent fiber routing design ensures the radius curvature of the fiber well and enough fiber storage space.



SPECIFICATIONS

Model	• GDFOSC-D48/2
Capacity	• 48 cores
Material	• PC, PC+ABS,PP
Dimension (mm)	• 390*Φ137
Inlet Cable Port	• Φ12-Φ25
Color	• Black
Protection Level	• IP68
Inlet / Outlet	• 1+4
Sealing Method For Inlets	• Heat shrinkable
Outlet Cable Port	• Φ8-Φ21



MECHANICAL DIAGRAM

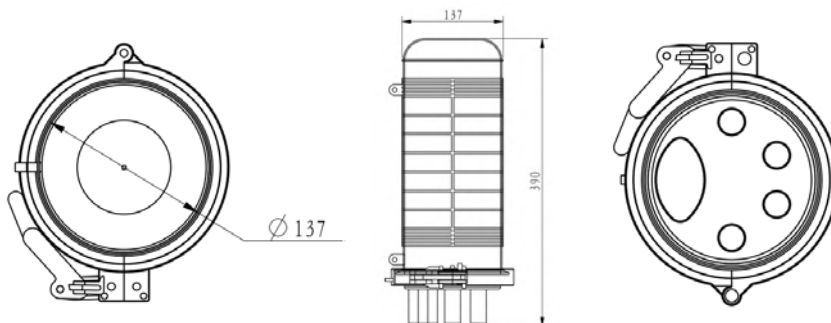

GDI reserves the right to make changes to the product at any time without notice. Information provided by GDI Technology is believed to be accurate and reliable. However, no responsibility is assumed by GDI Technology for its use, nor for any infringements of patents or other rights of third parties which may result from its use.

GDI Technology products are not authorized or warranted for use as critical components in equipment that requires an extremely high level of reliability. A critical component is any component of a life support device or system whose failure to perform can be reasonably expected to cause the failure of the life support device or system, or to affect its safety or effectiveness.